

escea.

GAS FIRE USER GUIDE



IB600
IB850
IB1100

www.escea.co.nz www.escea.com.au

G8861_4 Userguide NZ/AUS

If the electrical cord is damaged, it must be replaced by the manufacturer, its service agent or similarly qualified persons in order to avoid a hazard.

The data label for this appliance, containing technical information and specifications, can be found adhered to the metal work under the burners.

DO NOT PLACE ARTICLES ON OR AGAINST THIS APPLIANCE.

DO NOT USE OR STORE FLAMMABLE MATERIALS NEAR THIS APPLIANCE.

DO NOT SPRAY AEROSOLS IN THE VICINITY OF THIS APPLIANCE WHILST IN OPERATION.

NEVER OPERATE THE FIRE WITH THE FRONT GLASS REMOVED.

IT IS NOT RECOMMENDED TO OPERATE THE FIRE WITH THE FASCIA PANELS REMOVED.

THIS APPLIANCE IS NOT INTENDED FOR USE BY YOUNG CHILDREN OR INFIRM PERSONS UNLESS THEY HAVE BEEN ADEQUATELY SUPERVISED BY A RESPONSIBLE PERSON TO ENSURE THAT THEY CAN USE THE APPLIANCE SAFELY.

YOUNG CHILDREN SHOULD BE SUPERVISED TO ENSURE THAT THEY DO NOT PLAY WITH THE APPLIANCE.

THE APPLIANCE MUST BE INSPECTED BEFORE USE AND SERVICED AT LEAST ANNUALLY BY AN AUTHORISED TECHNICIAN.

THIS APPLIANCE MUST BE INSTALLED IN ACCORDANCE WITH THE MANUFACTURERS WRITTEN INSTRUCTIONS.

escea. NZ LTD
31 Devon St, PO Box 5277
Dunedin, New Zealand
E-mail: info@escea.co.nz
Web: www.escea.co.nz
Phone: +64 3 4790302

Distributed in Western Australia by
Australian Heating Distributors
31 Clune Street
Bayswater, Perth, Western Australia
web: www.escea.com.au
Phone: +61 8 93737000

Distributed in Australia by
Glen Dimplex
Unit 2, 205 Abbotts Road
Dandenong, Melbourne
web: www.escea.com.au
Phone: +61 3 87873567

escea.

Contents

| | |
|--------------------------|----|
| Remote control Layout | 2 |
| Basic Operation | 3 |
| Remote Keylock | 5 |
| Setting The Remote Time | 5 |
| Timer Operation | 6 |
| Auxiliary On / Off | 8 |
| Overtemp shut off mode | 9 |
| Sound & Smell | 11 |
| Fascia, Log & Glass Care | 13 |
| Trouble shooting | 15 |
| Warranty | 18 |

Remote Control Layout

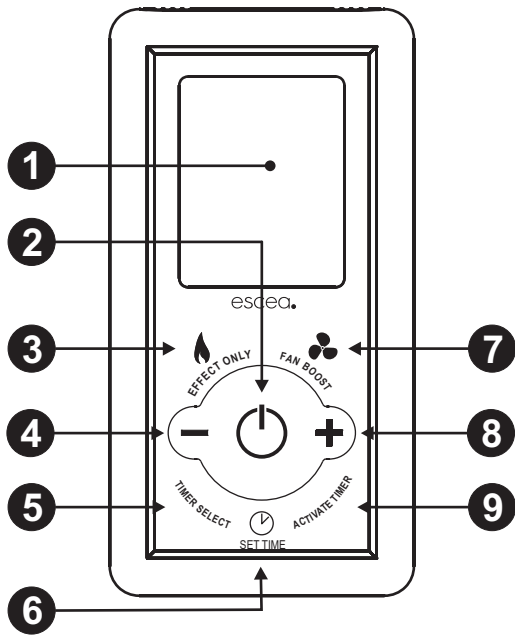

- 1 Display** Shows Temperature settings and status of timers and other functions.
- 2 On/Off** Switches the appliance on and off.
- 3 Flame effect** Places the fire in a constant low output mode.
- 4 Minus** Adjusts the temperature and time settings down. NOTE: The fan will operate at its lowest setting.
- 5 Timer Select** Allows you to program in advance the times you wish to automatically turn the fire on and off.
- 6 Set Time** Allows you to set the clock.
- 7 Fan Boost** Puts the fan into a high output mode.
- 8 Plus** Adjusts the Temperature and time settings up.
- 9 Activate Timer** Enables the timers.
- 3 + 7 Key Lock** Enables and disables the remotes key lock

Display Layout

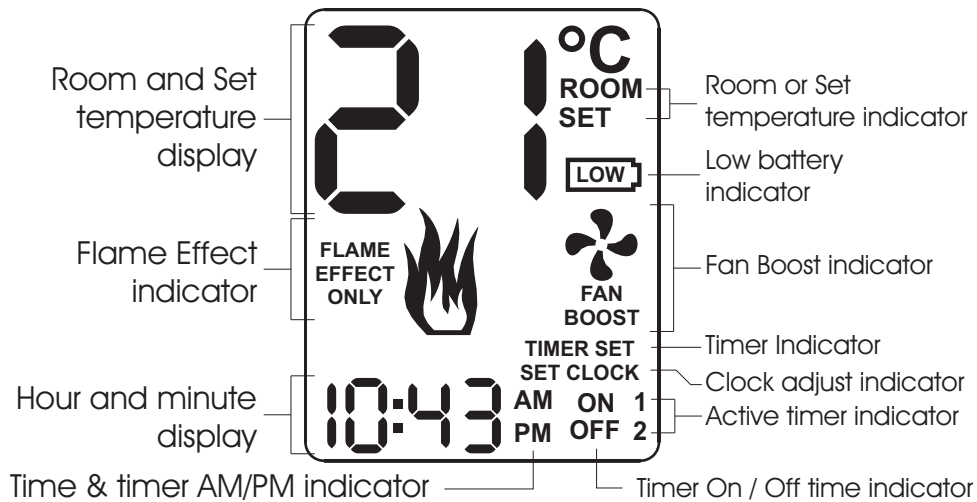

Basic Operation

Initial Start/Battery Placement.

Remove the battery cover on the rear of the remote. Insert the new "AA" size batteries, being careful of the polarity. You should now see on the display of the remote the time showing "0:00". To turn the fire on, press the "POWER" button once, and within a few seconds the fire will light.

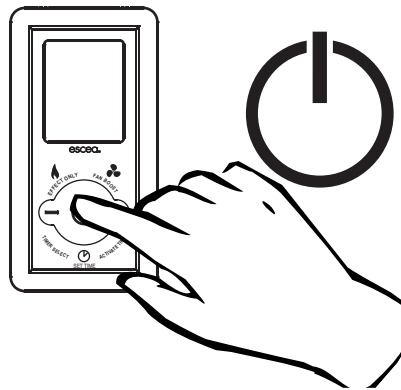

NOTE: Between ignition attempts the remote will alternately show the remote's "Set" temperature and a rotating segment indicator to show that the fire is in start up mode and will try to ignite again.

NOTE: In Australian fires only there is a statutory 5 minute delay between ignition retries.

Adjusting the Room Temp

To set the room temperature, press the 'plus' or 'minus' buttons repeatedly until the display is showing the desired temperature. The remote will then revert back to the 'current' room temperature after 30 seconds. The front burner will run continuously whilst the middle (where fitted) and rear burner will operate according to the temperature set by the remote.



Basic Operation Continued...

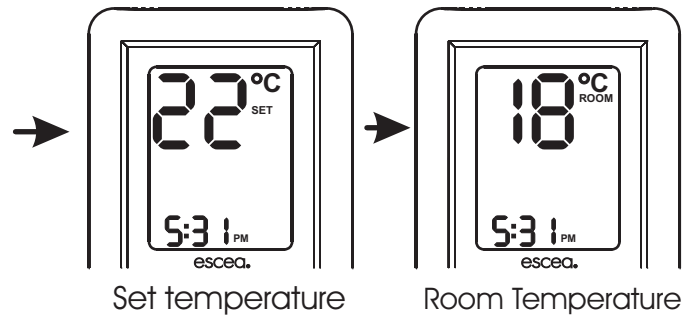

Fan Boost

The fire has three FAN SPEED settings. The first low fan speed will run automatically on start-up. The second fan speed will automatically switch on or off with the increase or decrease of the set temperature, and the third fan speed is an optional FAN BOOST speed, which can be accessed on your remote. Pressing the FAN BOOST button will increase the fan speed to its maximum. This mode will increase the circulation of heat from the fire. When this mode is not on, the fire will still use fan speeds one and two.

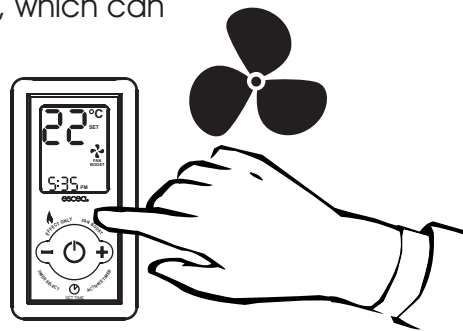

Effect Only

Pressing the EFFECT ONLY button will only turn on the front "Flame Effect" burner. This mode is intended as an ambient effect, though some heat will still be produced and the fan will operate at its lowest setting in this mode.

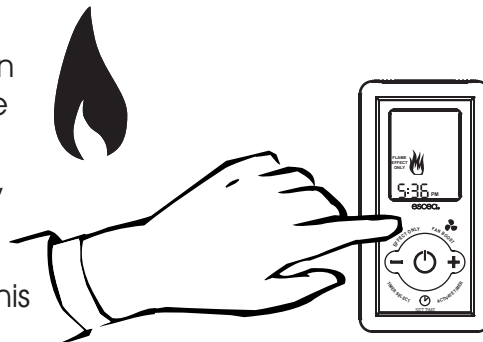

NOTE: The fan may continue to operate for a few minutes after the fire has been switched off to remove any excess heat.

Setting The Time

Press and hold the "SET TIME" button for more than two seconds and this will allow you to set the hour including "AM" or "PM" using the **+** PLUS or **-** MINUS buttons.

Pressing the "TIME SET" button again will allow you to set the minutes.

Press the button one more time to exit the "SET TIME" mode.

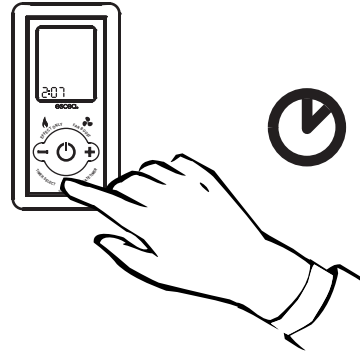

Keylock (Optional)

Should you wish to keep the fire from being tampered with by children or to discourage people from altering the temperature you can engage a keylock function which stops the remote buttons from changing any settings. To engage the keylock simply press the "Flame Effect" and "Fan Boost" buttons simultaneously until the main temperature digits display "LO".



To disengage the keylock again press and hold the "Flame Effect" and "Fan Boost" buttons simultaneously until the main temperature digits display "UL" and normal access to the remote functions will be available.

NOTE: The "power" button will still be able to turn the fire off. But once turned off no functions will be available until the keylock has been removed.

Timer Operation

Timers are a great way of starting the fire when you are not around to turn it on. The timers can be set so you can wake up or come home to a warm environment.

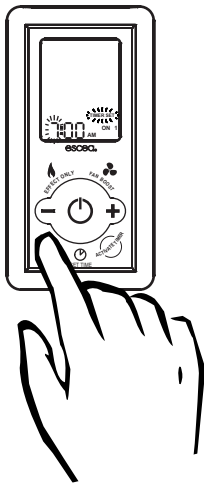

After pressing the TIMER SELECT button the TIMER SET indicator and the hour figure on the clock will start flashing. On the bottom right of the display you will also see the word "ON" and the number "1". This indicates that you are currently editing the hour that the fire will turn "ON" for timer "1". Pressing the **+** PLUS or **-** MINUS button will change the hour.

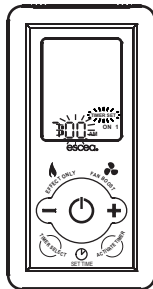

Pressing the TIMER SELECT button again will make the minute figures start flashing. You will continue to see the "ON" and the number "1". This indicates that you are currently editing the minute that the fire will turn "ON" for timer "1". Pressing the **+** PLUS or **-** MINUS button will change the minute.

Timer Operation Continued...

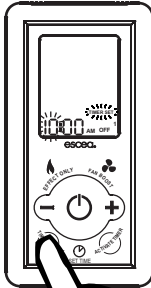

Pressing the TIMER SELECT button again will make the hour figure start flashing once again. Though now you will see the "OFF" indicator as well as the number "1". This indicates that you are currently editing the hour that the fire will now turn "OFF" for timer "1". Pressing the **+** PLUS or **-** MINUS button will change the hour.



Again pressing the TIMER SELECT button will start the minutes flashing for you to finish editing the "OFF" time for timer 1.

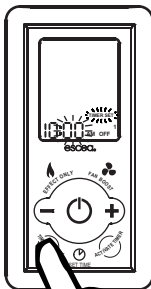

Pressing the TIMER SELECT button will begin the cycle all over again for timer "2".

NOTE: If you do not wish to set timer '2', using the plus or minus keys, navigate to '0:FF' which you will find between '11:00' and '0:00'. **Press 'Timer Select' again to exit.**



Activate Timer

This option allows you to activate your selected times. Pressing once will activate 'Timer 1'. Press twice will activate 'Timer 2' and by pressing again you will activate them both.

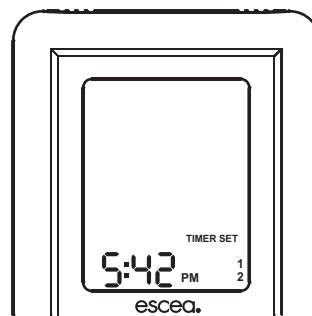
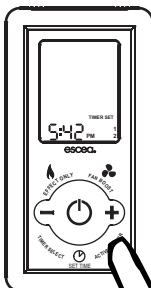

Auxiliary On/Off Button

escea gas fires also have a manual On/Off button located under the bottom fascia panel as shown below.

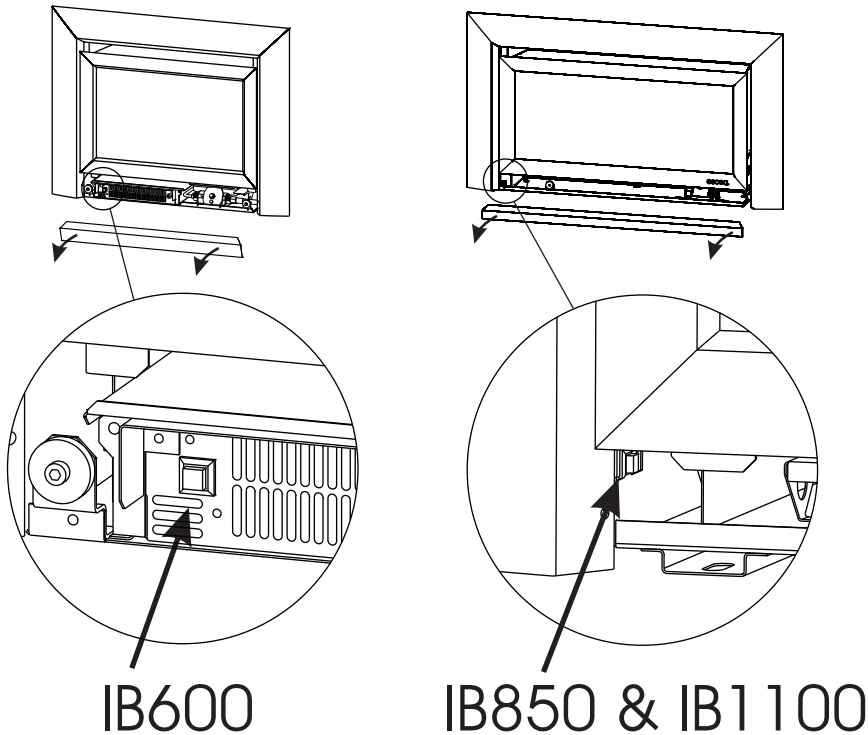

This button should be used if the wireless control becomes lost, damaged or its batteries are flat. Pushing "AUX on/off" button once will start the heater and it will run at a medium heat output setting until "AUX on/off" is pushed again to shut the heater down.

Over Temp Shutoff Operation

(Optional)

By default Escea gas fires continue running at their lowest setting when the "Room" temperature has reached the "Set" temperature. However, in some cases the output of the fire, at its lowest setting, may exceed that which is needed to keep the room at a steady temperature and the "Room" temperature may continue climbing above the "Set" temperature.

Your Escea gas fire has a setting where it will turn off all the burners once the "Room" temperature exceeds the "Set" temperature and will re-light the burners when the "Room" temperature falls back below the "Set" temperature. This is referred to as the "Overtemp Shut Off Mode".

To enable "Overtemp Shut Off Mode", so the fire will turn off all burners when the "Room" temperature climbs above the "Set" temperature, you need to follow the steps below to make the adjustment to your Escea remote.

STEP 1 While the remote is in its "OFF" mode with only the time showing on the display (as shown in the picture to the left), press the **- MINUS**, **+ PLUS** and **♣ FAN BOOST** buttons simultaneously (as shown below right) until all the characters on the display light up.

This will put the remote into test mode and the two big temperature digits should begin counting from 0 to 99 repeatedly.

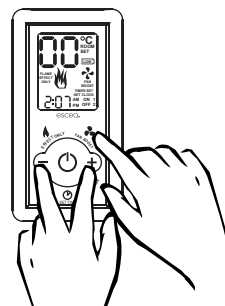
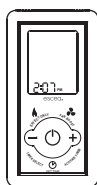

To turn **ON** the "Over Temp Shut Off Mode".

STEP 2 Press the "TIMER SELECT" Button and you will see that the temperature digits stop counting and will momentarily display "ON" to confirm the setting has been made.

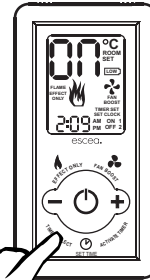

STEP 3 To exit the test mode press the ON/OFF button.



To turn **OFF** the "Over Temp Shut Off Mode", so the burners remain lit when the "Room" temp reaches and goes above the "Set" temp, repeat step 1.

STEP 2 Press the "ACTIVATE TIMER" Button and you will see that the temperature digits stop counting and will momentarily display "OF" to confirm the setting has been made.

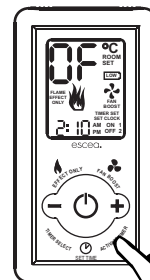

STEP 3 To exit the test mode press the ON/OFF button.



Sound & Smell

Note: Each time the fire is lit from cold the glass will fog up with condensation. This is normal and the condensation will disappear within a few minutes once the glass heats up.

Sounds

It is possible that you will hear some sounds from your gas appliance. This is perfectly normal due to the fact that there various types of materials used within your appliance. Listed below are some examples. These are all normal operating sounds and should not be considered as defects in your appliance.

Fan:

Escea gas appliances use electric fans to push heated air further into the room. It is not unusual for the fan to make a “whirring” sound when ON. This sound will increase or decrease in volume depending on the thermostatic settings.

Gas Control Valve:

As the gas control valves turn ON and OFF, a dull clicking sound may be audible. These sounds are part of the normal operation of the fire. When the fire is switched off after being run for a while, there may be popping and fluttering noises as the residual gas in the burner burns away. These are normal and should be no cause for concern.

Appliance Metalwork:

Different types and thicknesses of steel will expand and contract at different rates resulting in some “creaking” and “ticking” sounds being heard throughout the heating and cool down cycles.

Sound & Smell

Smells

The first few times the unit is operated after installation, the unit may release an odour and the flames will appear orange caused by the curing of the paint, the burning off of the starch in the ceramic logs and the oils in the metal. This is a temporary curing process which will disappear with use.

A deposit on the inside of the glass, caused by the starch in the logs may appear as a build up after several uses. If this film is not removed, it will bake on and may become difficult to remove. When the glass is cold, remove it (see page 10) and clean the inside with a non-abrasive cleaner.

WARNING

DO NOT ATTEMPT TO CLEAN THE GLASS WHILE IT IS HOT. NEVER OPERATE THE UNIT WITH THE GLASS REMOVED.

Fascia, Log and Glass Care

If the fire is operated with finger (and other) marks present on the fascia panels there is a risk of them being burnt into the fascia paintwork as the fire gets hot from normal running. The fascia panels should be kept as clean as possible and all cleaning should be carried out when the fire is off and cold.

NEVER, EVER RUB THE FASCIA

The outside of the fascias must only be cleaned with a damp cloth. The high temperature silver powder coating that is used on Escea fascia parts contains certain amounts of aluminium that when rubbed too hard will oxidise leaving a big black smudge that cannot be removed.

The glass can be cleaned, inside and out, using most domestic glass cleaners providing that all residue is removed with a CLEAN and DRY cloth. Stubborn marks can be cleaned using a ceramic cook top cleaner.

Cleaning maintenance will need to be carried out whenever soot builds up on the logs and/or inside of the glass.

If soot build up becomes excessive or regular, then it is recommended that you contact an authorised Gas Fitter to service your fire.

Fascia, Log and Glass Care

Step 1: Lift off the inner fascia by pulling the base of inner fascia out and lifting it up and off.

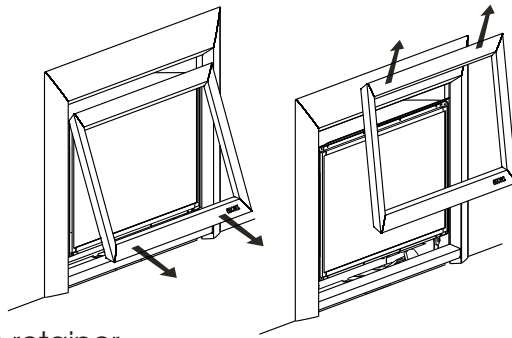

Step 2: Unscrew the top glass retainer and remove it. Take care that the glass does not fall forwards at this stage.

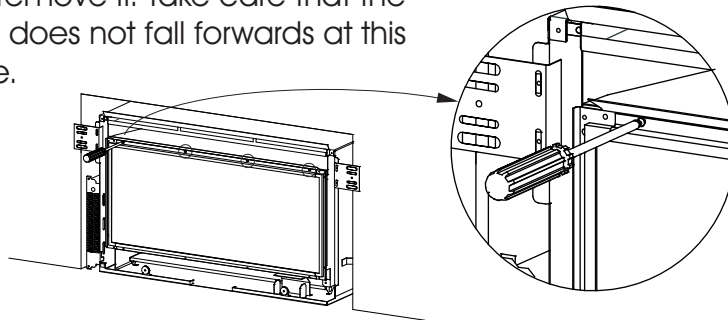

Step 3: Lift out glass and place it carefully aside.

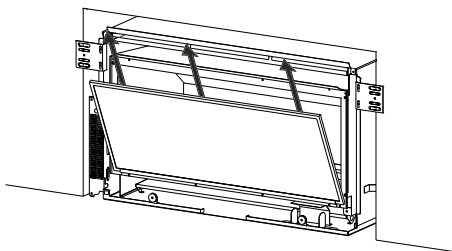

Step 4: Take out log set and gently brush any soot from log with a soft hearth brush. The burner tops can be vacuumed too.

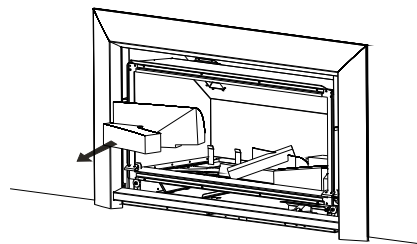

Continued...

Fascia, Log and Glass Care

Step 5: Clean the inside and outside of glass with normal glass cleaning products. Use a **CLEAN DRY** cloth only. Stubborn marks may be cleaned with a ceramic glass cleaner.

Step 6: Replace in opposite order and test run heater.

Troubleshooting

escea gas fires communicate both to and from the fire and remote. This enables the remote to provide some basic fault finding information that is useful in diagnosing faults with your gas supply or flue.

NOTE: The remote will take a minute or two to receive and display the error from the fire. Pressing the plus or minus keys will update the remote



Electronics
overtemp.

IB600 - Usually associated with a four sided fascia being mounted too high resulting in an insufficient air gap between the lower removable strip and the bottom of the outer fascia.

All models - This fault may be indicative of the gas regulator being set to high resulting in excess heat build up. **Note:** This error has a permanent lock out and will require the unit to be reset 10 minutes *after* the initial error (Reset means turning the power to the fire off "at the wall" then on again after a few seconds).

Continued...

Troubleshooting



Flame failure or
power flue trip

Power Flue Unit
NZ Only
(PFU)



The fire has tried to light three times and failed.

- Check gas supply and other gas appliances to see if they are affected. If you have two separate LPG cylinders, switch over to the full bottle or contact your gas supplier. You may need to retry igniting the fire a few times after re-establishing gas supply.

- Check that there has not been a significant reduction in air pressure inside the house (such as an extractor fan in a nearby kitchen) which can pull flue gas back down through the firebox "snuffing" the flames.

Additionally if the living space is built such that no adventitious ventilation is available (small gaps around doors widows etc..) the flow of exhaust gasses may stall and snuff the flames (this may produce an E3 error also). This can be checked by opening a nearby window or door to the outside when the fire is faulting to see if there is an improvement. In this case it may be beneficial to add some ventilation to the living space to balance the air being drawn up the flue.

- Alternatively this may indicate a problem with a PFU installation. If for any reason the exhaust flow is stalled or backs up, the pressure switch in the PFU will trip and shut off the burners. If this flow disruption continues for longer than the normal ignition period it may cause an E2 Error. Brief wind gusts may trip the pressure switch and shut off the burners momentarily but the fire will attempt to relight immediately after the pressure switch resets with normal exhaust gas flow.

Continued...

Troubleshooting



OR



Draught Diverter
Spill Switch.
The flue is not
drawing properly.

A gust of wind pushing exhaust gases back down the flue or a significant reduction in air pressure inside the house which is pulling exhaust gases back down the flue (such as a extractor fan in a nearby kitchen). Alternatively if the living space is built such that no adventitious ventilation is available (small gaps around doors widows etc..) the flow of exhaust gasses may stall and trip the draught diverter spill switch (this may produce an E2 error also). In this case it may be beneficial to add some ventilation to the living space to balance the air being drawn up the flue. In the unlikely event that the fans have stalled and the snap disk on the lid of the fire has tripped this would show an E3 also. Simply check that the fans are running normally after resetting and running the fire again. Check that the flue is not blocked. If none of these things can be obviously identified please contact your local installation company to check the flue installation. Ensure there are no extractor fans operating or some other factor that would draw air out from the room.

Note: This error has a permanent lock out and will require the unit to be reset 10 minutes *after* the initial error (reset means turning the power to the fire off "at the wall" then on again after a few seconds).



Valve Overtemp
Error

or



Temp Sensor
Error

Contact your local service agent.

If you are experiencing continual problems please contact your local service agent.

Power Failure

In the event of power failure the fire will immediately shutdown and the gas valves will automatically close. If the remote was turned off after the power cut then the fire will return to standby mode once the electrical supply is restored until its next use. If however the remote was left in the on mode then the fire will relight within a few minutes of the electrical supply being restored.

Warranty

escea

WARRANTY TERMS & CONDITIONS:

If, and only if, the Product is installed as per ESCEA's installation manual and the step by step warranty procedure has been followed as per instructions issued by ESCEA, (documented in the agent manual), and that the product is operated and maintained in accordance with ESCEA operating and maintenance instructions, then for the first period of 12 months from the date of purchase ESCEA will pay the cost of repairing or replacing any part of the Product that is deemed by ESCEA to be faulty.

For the second period of 12 months from the date of purchase ESCEA will supply replacement parts only, without charge.

Parts and Labour for the first 12 months:

- a) ESCEA at its discretion may modify, adjust, repair or replace the faulty products. The warranty period on parts and labour shall be for 12 months from the acceptance date of the Products by the ESCEA retailer.
- b) Labour costs will only be reimbursed when ESCEA specified procedure has been followed, and ESCEA has authorised service work before it was carried out.

Parts for the second 12 months ONLY:

- a) ESCEA at its discretion will provide replacement parts to the retailer or service agent. Faulty parts MUST be returned to ESCEA. The parts only warranty period shall be for 12 months and will commence 12 months after the acceptance date of the Products by the ESCEA retailer.

General Terms:

1. All repairs made within the warranty period shall be covered by warranty for a period of 3 months from the date of completion of the repair, or for the remainder of the overall product warranty, whichever is the longer.
2. If the buyer or any other party modifies any part of the Product within the warranty period without the written consent of ESCEA then the warranty shall be void. ESCEA may, at their sole discretion, decide that the warranty is void in relation to any part of the product, which has been modified.
3. Escea must be notified of all warranty claims as soon as possible, but in any event not later than 2 weeks of becoming aware of the circumstance giving rise to the claims.
4. Escea's liability in this warranty is limited to the repair and replacement of faulty parts or workmanship by escea. No other resultant direct or indirect costs or expenses can be claimed.