

OWNER'S
m a n u a l

coolair[®]
CPL SERIES

CONTENTS

Introduction	Page 2
Thermostat Functions	Page 3
Standard Bleed System and Drain Valve	Page 7
Maintenance	Page 8
Troubleshooting	Page 10

Congratulations on choosing a new cooler for your home.

Your cooler is built from the highest quality materials and engineered to provide many years of economical, trouble free cooling.

Please take a few minutes to read these instructions so you have a full understanding of how to operate your cooler. Your installer should demonstrate the features and procedures set out in these instructions. The installer should also provide you with a Model and Serial number, which can be filled out on the last page.

Keep these instructions in a safe place for future reference.

EFFECTIVE COOLING

To provide efficient cooling or ventilation the building must have sufficient exhaust openings to outdoors in the form of doors, windows or other vents. To assist air circulation, open windows or doors that are furthest from the outlet vent in each room. In every room that has an outlet vent, provide an exhaust opening about 2 or 2.5 times the vent size of the room. Where the design of the building prevents adequate exhaust, consideration should be given to the provision of mechanical extraction such as an exhaust fan.

Total minimum openings for the whole building are demonstrated by the following table:

Cooler Model	Exhaust Opening
CPL450	2.0m ²
CPL600	2.5m ²
CPL700	2.5m ²
CPL850	3.0m ²
CPL1000	4.0m ²
CPL1100	4.0m ²

Please note that an average size door is 1.5m.

STARTING YOUR COOLER

The ON/OFF button turns the cooler on and off.

There are two modes of operation to choose from, Automatic mode or Manual mode. When the cooler is turned on, it will start in the mode of operation it was in when last turned off.

If your cooler has not been operated for a while, then when you start it, "Pre Cool Cycle" may sometimes flash on the display as shown. This indicates that the water pump will operate to saturate the cooling pads for a few minutes before the fan is turned on. This is to ensure that when the fan starts, only cool air enters your home.

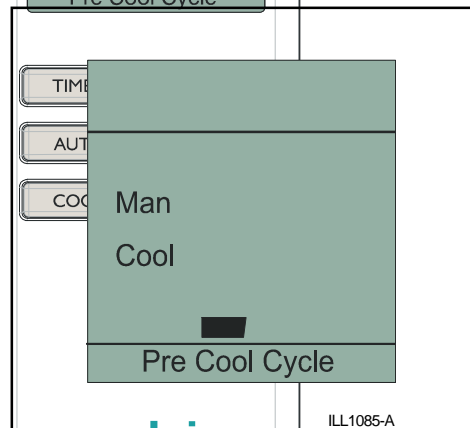
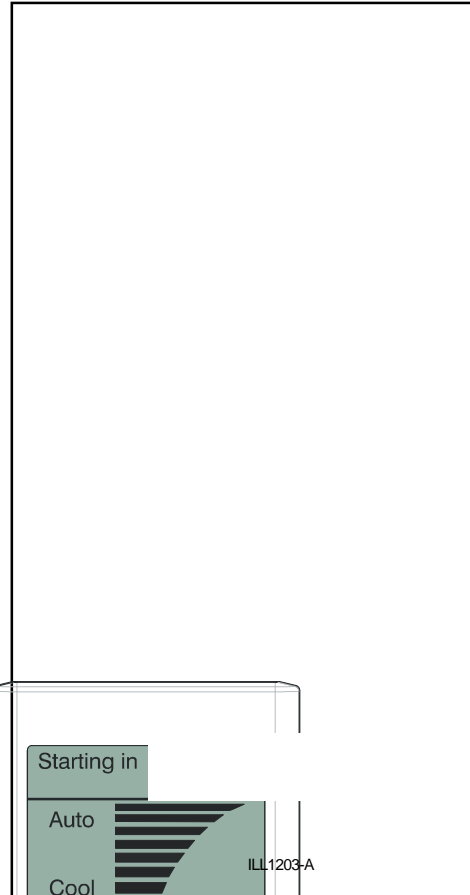

AUTOMATIC MODE

The AUTO button switches between Automatic mode and Manual mode. When "Auto" is displayed the cooler is under Automatic control and will operate according to the temperature sensed at the thermostat.

When the cooler is turned on, it will read the temperature and set the cooler operation accordingly. If the temperature increases at the thermostat, then the fan speed will increase. As the temperature decreases the fan speed will decrease until the cooler turns off.

Press ▲ or ▼ to override the automatic cooling level setting and adjust your room temperature.

MANUAL MODE

To switch to Manual mode, press AUTO until "Man" appears in the display. In Manual mode the cooling level can be manually adjusted.

In Manual mode, press **COOL** to choose between circulating cool air or uncooled air. When "Cool" is displayed, fresh cool air will circulate into your home. When "Vent" is displayed as shown, fresh uncooled air will circulate through your home.

Press ▲ to increase the fan speed and circulate more air. Press ▼ to decrease the fan speed and circulate less air. Press once to change the speed by one increment. Hold the button down to change the speed more quickly.

AUTOMATIC MODE DISPLAY

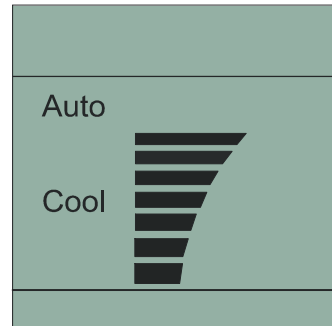

ILL1096-A

MANUAL MODE DISPLAY

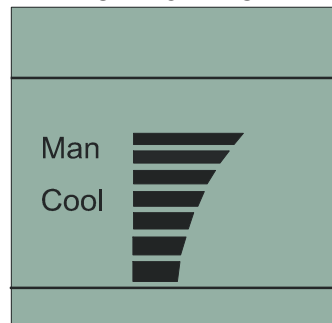

ILL1097-A

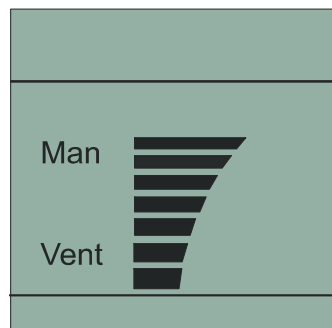

ILL1098-A

TIMED AUTOMATIC START

You can set the cooler so that it will turn on after a set number of hours.

1. To set the delayed start time, press **TIMER** with the cooler turned OFF. "Starting in" will be displayed as shown with the last mode of operation (Manual or Automatic).

2. If you want the cooler to turn on in Automatic mode with the previous settings, then press **AUTO** until "Auto" is displayed. Alternatively, if you want the cooler to turn on in Manual mode, press **AUTO** until "Man" is displayed and then press **COOL** and then ▲ or ▼ to set the required fan speed.

3. To set the time until the start, press **TIMER**.

4. Then press ▲ or ▼ to adjust the time. The cooler can start up to 24 hours in advance.

5. Press **TIMER** again to initiate the timed automatic start. The timed start will not repeat.

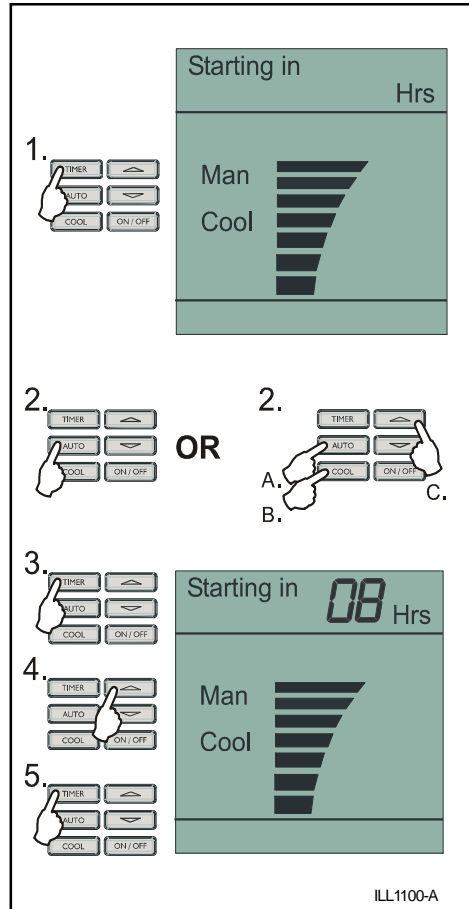

TIMED AUTOMATIC STOP

You can also set the cooler so that it will turn off after a set number of hours.

To set the delayed stop time, 1. press **TIMER** when the cooler is running. "Stopping in" will display as shown. 2. Press ▲ or ▼ to adjust the number of hours before the cooler will stop. The maximum delay setting is 24 hours.

3. Press **TIMER** again to begin the timed stop.

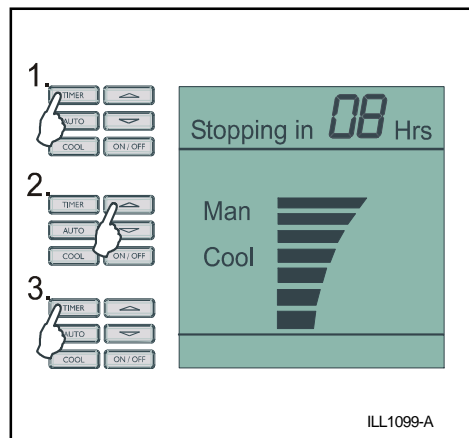

USING THE COOLER

Now that you have read these instructions, press **ON/OFF** to turn your cooler on. If the cooler has not operated for a while, "Pre Cool Cycle" will flash on the display. The "Pre Cool Cycle" will begin and will take only a few minutes to complete. After this time, the fan will come on automatically, and you can enjoy the comfort of cool fresh air!

AIR TOO COLD

With the cooler running in Automatic mode, you may find that you are too cold or that the cooler is blowing too much air. Press ▼ to lower the automatic temperature setting and reduce the amount of cooling.

If you are too cold with the cooler running in Manual mode, then press ▼ to reduce the fan speed. You can also circulate fresh uncooled air by pressing **COOL** until "Vent" displays.

AIR NOT COLD ENOUGH

You may find that with the cooler running in Automatic mode, you are not cool enough. Simply press ▲ to increase the cooling rate.

If you are not cool enough with the cooler running in Manual mode, then press ▲ to increase the fan speed. Ensure that cooled air is circulating by pressing **COOL** until "Cool" displays.

You can experiment with the settings on your thermostat. This is the best way to get the most from your cooler.

This cooler comes with a standard bleed system or the optional automatic drain valve.

STANDARD BLEED SYSTEM

During operation, the standard bleed system will drain small amounts of water. This ensures fresh water is continually added to dilute salt accumulation in the water caused through evaporation. This helps keep the cooler in good condition and ensure optimum performance.

The bleed rate will depend on local operating conditions and will be set by the installer.

AUTOMATIC DRAIN VALVE

If the drain valve was installed instead of the standard bleed system then your cooler will automatically drain after a set time of continuous operation. This ensures the water is always fresh and helps maintain your cooler in good condition to ensure optimum cooling performance. The frequency of the automatic drain may have been adjusted by your installer according to the general water quality in your area.

When the cooler is turned off for 72 hours, the drain valve will open automatically and empty water from the cooler. When the cooler is turned on again, fan operation will delay for a few minutes while the tank refills and the cooling pads are saturated again.

At any time when the thermostat is OFF, you can drain the cooler by pressing and holding ▲ and ▼ for 1 second. The display will show "dr" to confirm the operation has activated.

Regular maintenance is essential to ensure the cooler operates efficiently for many years. Services must be performed before and after the summer season. More frequent servicing may be required in dusty conditions or in areas with poor water quality.

WARNING

We recommend maintenance is carried out by an authorised Dealer or Service Agent. Climbing onto and working on the roof can be hazardous and could result in personal injury or property damage. Failure to carry out maintenance will affect your warranty coverage.

HEALTH REGULATIONS

Please note that some State regulations require evaporative air coolers to be serviced at specific intervals.

END OF SEASON SERVICE

- Turn off the power supply to the cooler.
- Turn off the water supply to the cooler.
- Remove the pad frames as shown .
- Turn off the power switch inside the cooler.
- Check and clean water channels in the lid.
- If fitted, first unclip and then remove the bleed system as shown. Allow the tank water to drain. Take care not to lose the o-ring.
- Thoroughly clean the tank and pump filter. Do not replace the bleed system. (If a drain valve is fitted this will not be necessary as it will automatically drain).
- Re-fit the pad frames.

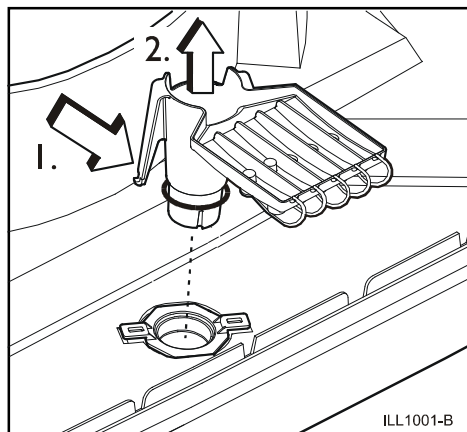
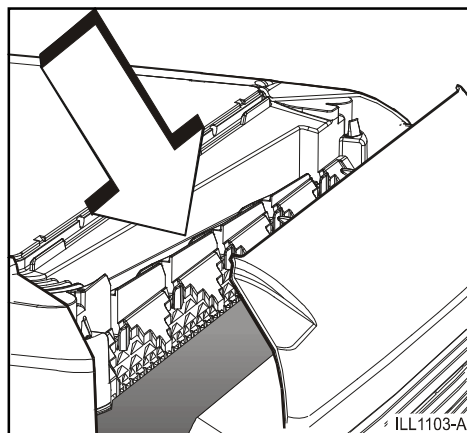
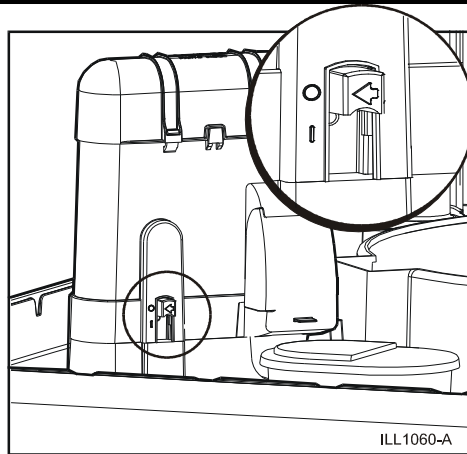

PRE-SEASON SERVICE

- Turn off the power supply to the cooler
- Remove the pad frames as shown.
- Ensure the power switch in the cooler is off.
- Gently wash the pads to remove any dust build up during the winter period. If the pads are in poor condition, replace them.

IMPORTANT: Do not damage the pads with high pressure water spray.

- Replace the bleed system if it was removed during previous maintenance and ensure the o-ring is fitted. (If fitted with a drain valve this will not be necessary as it will automatically close when the cooler is turned on).
- Turn on the power switch inside the cooler.
- Turn on the water and then the power.
- Re-fit the pad frames and run the cooler.

WARNING

Do not run the cooler with the pad frames removed.

REMOVAL OF PAD FRAMES

To remove a pad frame, insert a flat screw driver tip into the slot as shown and lever until disengagement occurs.

Take hold of the pad frame and pull it towards you until the internal side clips disengage.

Pivot the pad frame outwards and lift up. Take care not to damage the pad. Repeat these steps for the remaining pad frames.

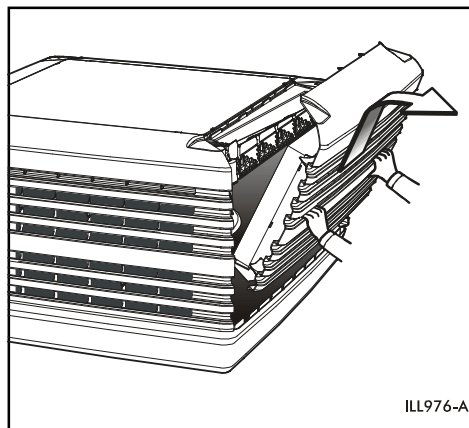
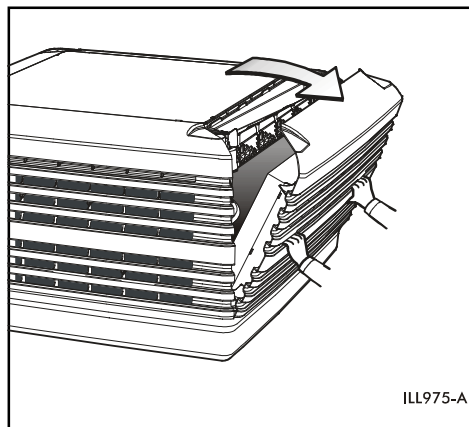
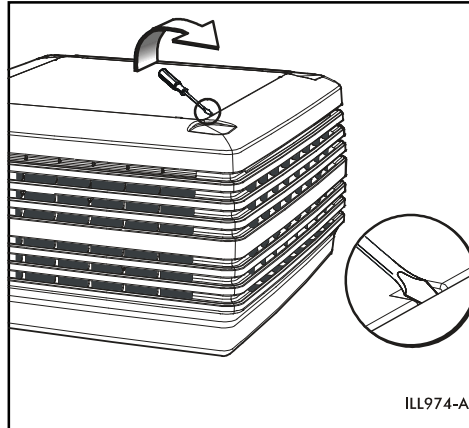

PROBLEM - Unpleasant Odour

	CAUSE	REMEDY
1.	Odour from new pads.	Allow time to condition by running the cooler.

PROBLEM - Inadequate Cooling

	CAUSE	REMEDY
1.	Dry pads.	Check water flow to pads. Ensure water supply is turned on.
2.	Insufficient exhaust openings for conditioned air.	Ensure sufficient openings. Refer to chart on page 2.
3.	Excessive ambient humidity. (See also insufficient exhaust.)	On days during the summer when the ambient humidity is high, the cooler will not reduce the temperature as much as on drier days.

If your thermostat display flashes "Service" or should you consider that your cooler requires service, you should contact your local Dealer or the Warranty Service number shown on the back cover.

When you contact your Dealer regarding service or warranty please quote the unit model number and serial number as shown below.

Model No. _____ Serial No. _____





Warranty Service
1300 650 644

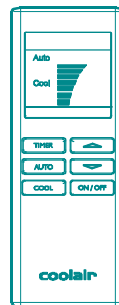

coolair[®]
C P L S E R I E S

834962-D

0601