



TRAVIS INDUSTRIES  
HOUSE OF FIRE

## GreenSmart™ Remote – Export Version

SKU 99300699 (NG)

SKU 99300698 (LP)

### Compatibility

---

This GreenSmart™ remote is compatible with the following Travis GreenSmart products:

- 564 SS GS
- 864 TRV GS
- 864 ST GS

### Packing List

---

- Transmitter with 3 AAA Batteries
- Receiver (with Cover Plate & Switch)
- LP or NG Stepper Motor (with screws and label - attaches to Valve)
- Wire Harness
- (2) #8 x 1/2" Machine Screws
- (2) Wire Ties
- Torx T-20 Wrench
- Wall Mount (for placing the transmitter on a wall)
- (2) Drywall anchors (for wall mount)
- (2) #8 x 3/8" Type B Screws

Transmitter

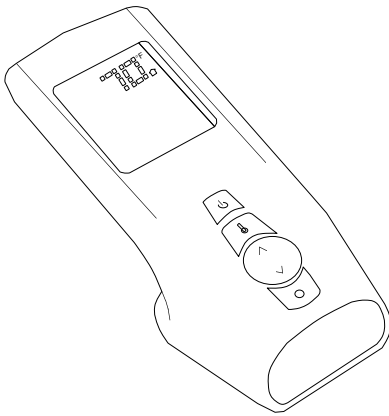

Receiver

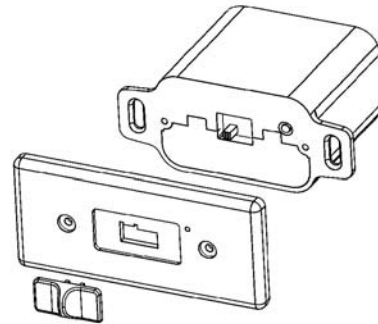

Stepper Motor

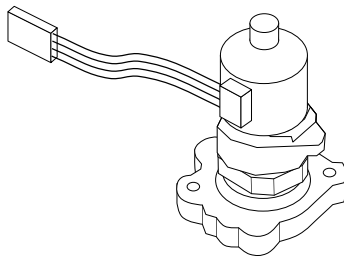

Transmitter Wall Mount

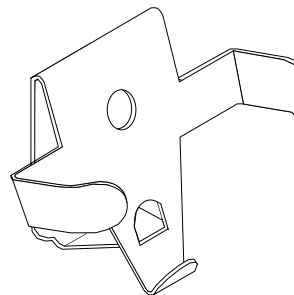



TRAVIS INDUSTRIES  
HOUSE OF FIRE

# GreenSmart™ Remote – Export Version

SKU 99300699 (NG)

SKU 99300698 (LP)

## Wiring Harness

The GreenSmart remote includes a wiring harness that replaces the stock wiring harness. Before installation, familiarize yourself with the updated wiring diagram (see the illustration below).

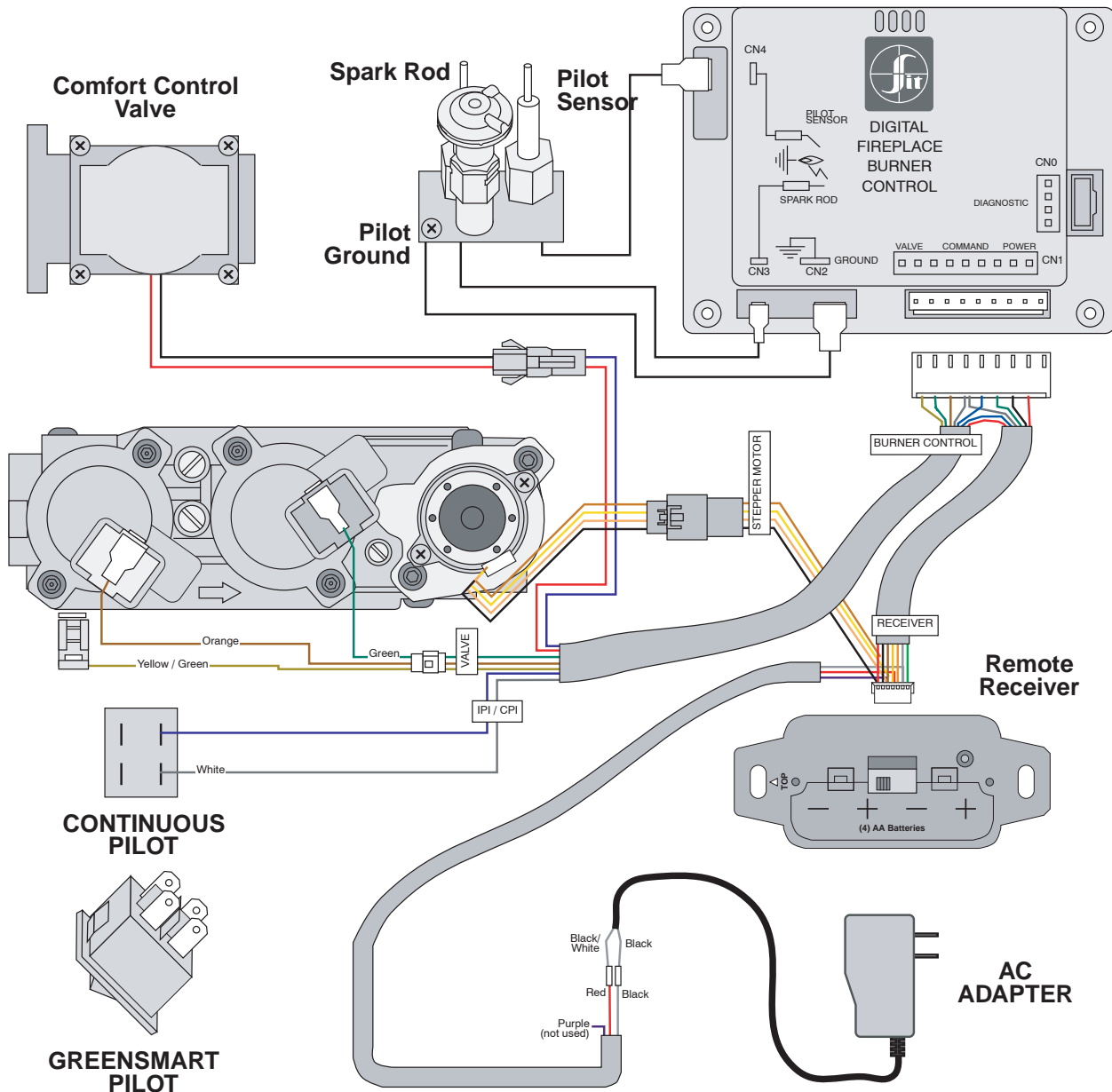



### Installation

**WARNING:** Make sure power to the fireplace has been shut off prior to installation.

**NOTE:** The installation pictures show a 564. Installation on other models is similar, take care to prevent any hot or moving parts from contacting any wiring.

- 1 Remove the concealment cover (if applicable - see Figure 1).



Figure 1

- 2 Unscrew the four screws holding the control cover in place (see Figure 2). Carefully remove the control cover (see Figure 3)



Figure 2



Figure 3

- 3 Unplug the ac adapter from the receptacle (see Figure 4). You can leave the ac adapter plugged into the wiring harness.



Figure 4



- 4 Disconnect the molex connector leading to the gas control valve (see Figure 5).  
**WARNING:** The tabs on the gas control valve are fragile. Take care when removing the molex connector to not pull or damage the wires or tabs.

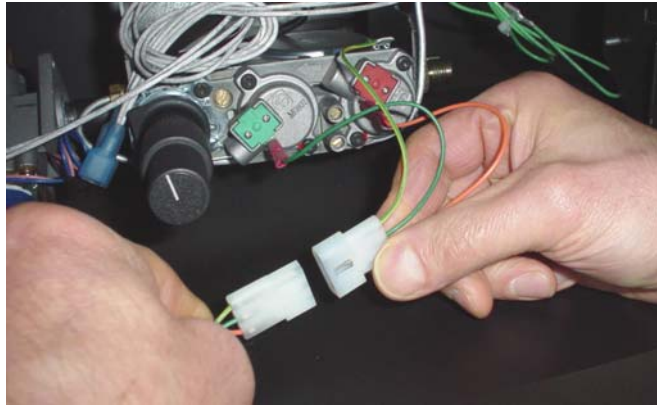

Figure 5

- 5 Disconnect the two leads on the back of the control panel for the IPI / CPI switch (continuous pilot / greensmart pilot – see Figure 6).



Figure 6

- 6 Disconnect the comfort control valve connection (see Figure 7). Disconnect the burner control connector from the fireplace burner control (see Figure 8).



Figure 7

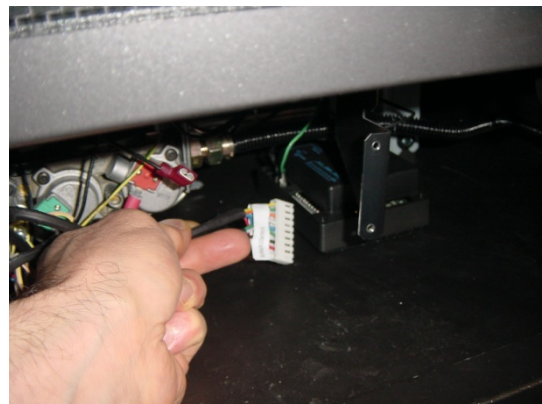

Figure 8



- 7 Unscrew the on/off/battery plate from the control panel (see Figure 9). Pull the plate and wiring forward (see Figure 10).



Figure 9

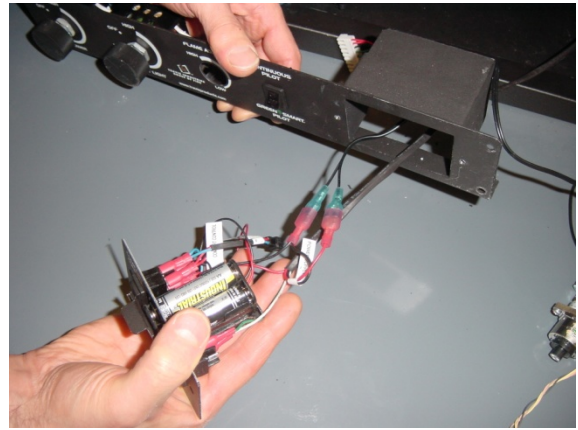

Figure 10

- 8 The control panel may have plastic wire-locks attached to the back (see Figure 11). Un-hook the wires from the wire-locks and remove the wiring harness, plate, battery holder, and ac adapter (see Figure 12). These items may be discarded (keep the batteries for the receiver).

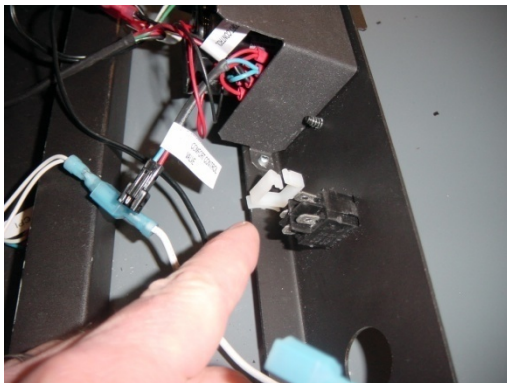

Figure 11

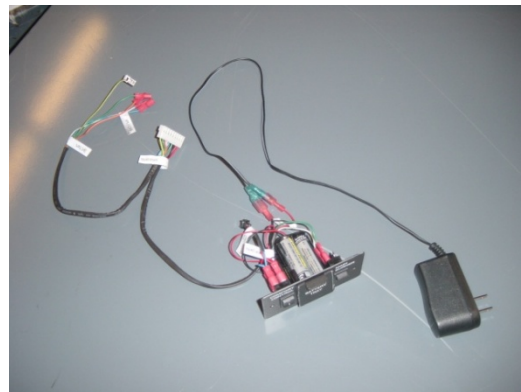

Figure 12

- 9 Use the included torx wrench to remove the stock regulator (see Figure 13). These items may be discarded.





Figure 13

- 10 The stepper motor (adjustable regulator) has an installation sheet included with it – make sure to follow all of the directions. Place the stepper motor on the gas control valve (see Figure 14) – **MAKE SURE IT IS CORRECTLY ORIENTED**. Secure using the screws included with the motor (see Figure 15) – tighten to 25 Lb-inches. Leak test this area after installation to verify proper installation.

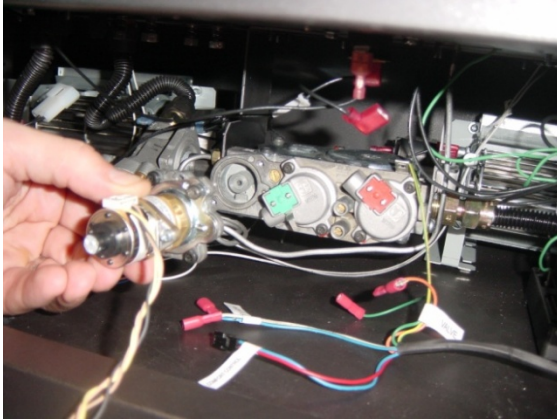

Figure 14

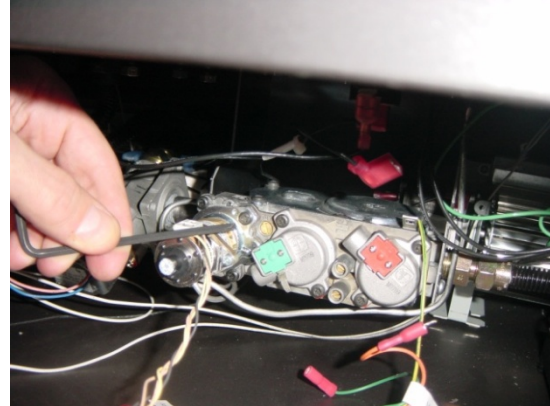

Figure 15

- 11 Place the GreenSmart wiring harness in front of the fireplace, noting the position of each connector
- 12 Attach the wiring harness to the burner control (see Figure 16). Attach the gas control valve molex connector (see Figure 17).

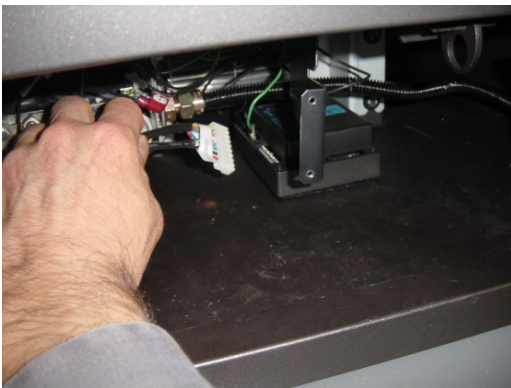

Figure 16

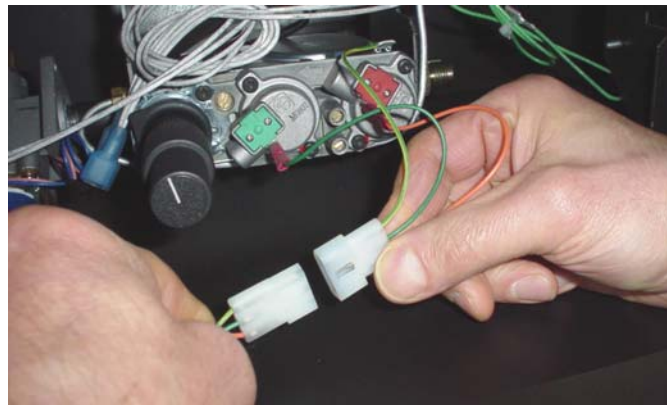

Figure 17



**TRAVIS INDUSTRIES  
HOUSE OF FIRE**

## GreenSmart™ Remote – Export Version

**SKU 99300699 (NG)**

**SKU 99300698 (LP)**

- 13 Attach the blue and white wires to the IPI/CPI switch (see Figure 18). Connect the wiring harness to the stepper motor (see Figure 19).

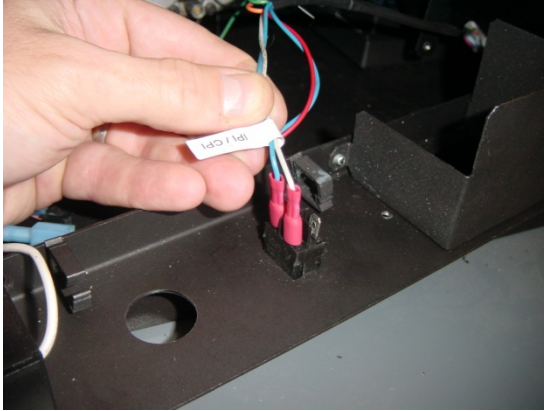

Figure 18



Figure 19

- 14 Attach the wiring harness to the comfort control valve connection (see Figure 20).

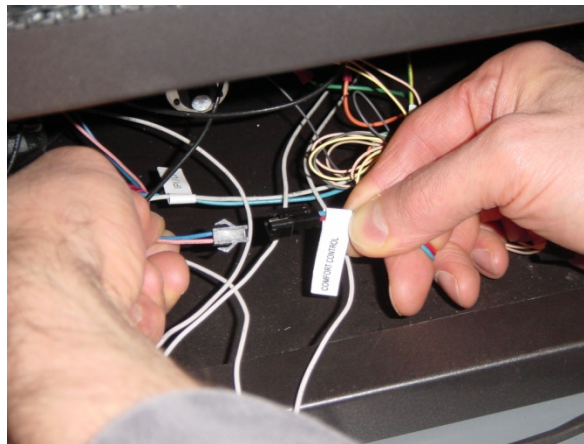

Figure 20

- 15 Plug the AC Adapter on the wiring harness into the receptacle on the fireplace.



- 16 Pull the “RECEIVER” connector through the control panel and attach to the receiver (see Figure 21). Then attach the receiver to the control panel with the two #8 machine screws (see Figure 22).



Figure 21



Figure 22

- 17 Place batteries into the receiver and transmitter (see Figure 23). Calibrate the receiver to the transmitter (see Figure 24 - use a paperclip to press the “PRG” button, let it beep, then press any button on the transmitter – the receiver should beep 5 times – see the operating instructions for further details).



Figure 23



Figure 24

- 18 Place the receiver coverplate (and switch) over the receiver (see Figure 25) and attach with the two screws included with the receiver (see Figure 26)



Figure 25



Figure 26





TRAVIS INDUSTRIES  
HOUSE OF FIRE

## GreenSmart™ Remote – Export Version

SKU 99300699 (NG)

SKU 99300698 (LP)

- 19 Clip any excess wiring into the wire clips on the back of the control panel (see Figure 27). Use the included wire ties, if necessary, to keep all wiring from contacting any hot or moving components. Re-attach the control panel (see Figure 28) and shroud (see Figure 1).



Figure 27



Figure 28

- 20 A wall mount is included with this kit for the remote. It may be mounted to the wall for easy access and storage. Use the included drywall anchors (and screws) to secure it to the wall (see Figure 29).

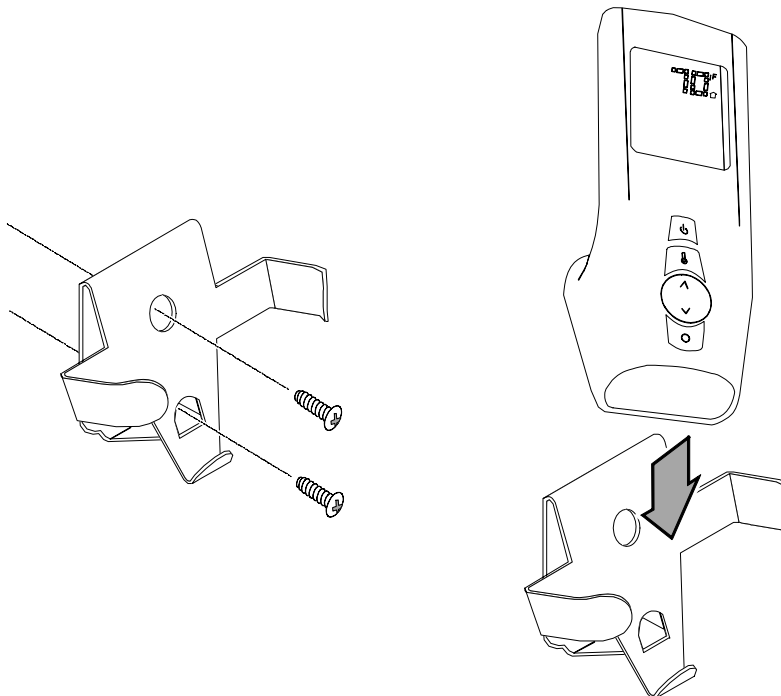

Figure 29

- 23 Restore power to the fireplace and test operation of the remote (see the instructions included with the remote).



TRAVIS INDUSTRIES  
HOUSE OF FIRE

# GreenSmart™ Remote – Export Version

SKU 99300699 (NG)

SKU 99300698 (LP)

## Battery Installation

### Transmitter Battery Installation

Install the three included AAA batteries into the remote (see Figure 30).

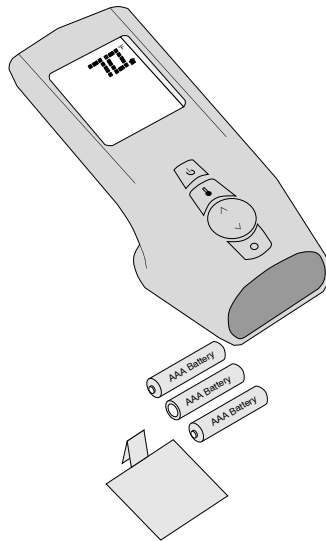

Figure 30

### Receiver Battery Installation

Install four AA batteries into the receiver (see Figure 31). You can use the batteries from the battery backup tray on the appliance. See the installation instructions for details. These batteries control the comfort control and act as a power-backup in case the household (AC) current goes out.

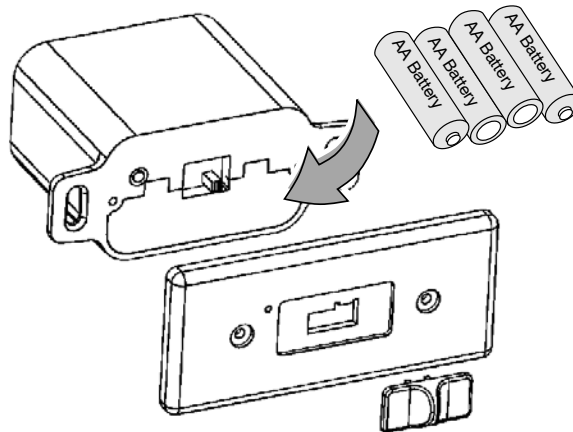

Figure 31



### Set-Up

#### Synchronize the Transmitter to the Remote

The transmitter will need to be synchronized to the receiver before the remote will work correctly. Synchronizing is done in the following two steps below (see Figure 32):

- Press the PRG (Program) button on the receiver using a paperclip or equivalent device (receiver will beep 3 times).
- Press the "ON" button on the transmitter (receiver will beep 4 times).

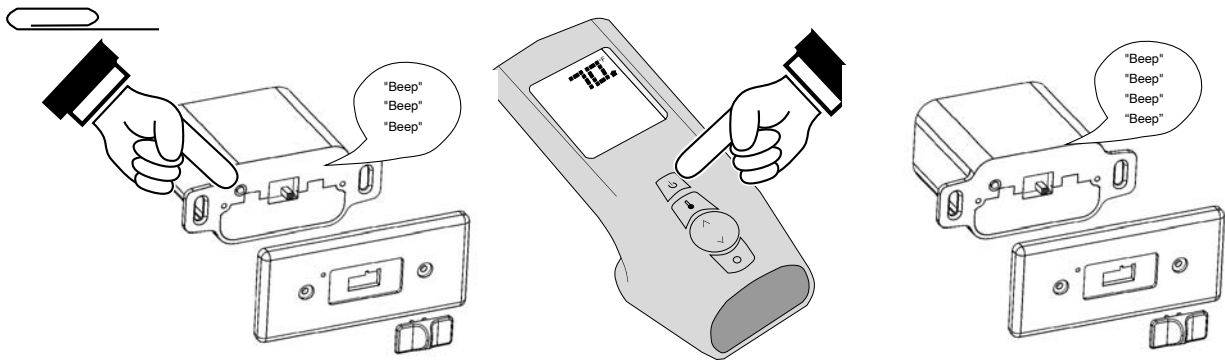

Figure 32

NOTE: If power is cut off to the receiver for an extended period of time, you may need to re-synchronize the remote.

#### Direct Fireplace Operation

The fireplace may be directly operated from the receiver. The three positions are below (see Figure 33):

**ON** – Fireplace burner turns on (regardless of transmitter settings).

**OFF** – Fireplace burner turns off (regardless of transmitter settings).

**REMOTE** – Fireplace is controlled by the transmitter.

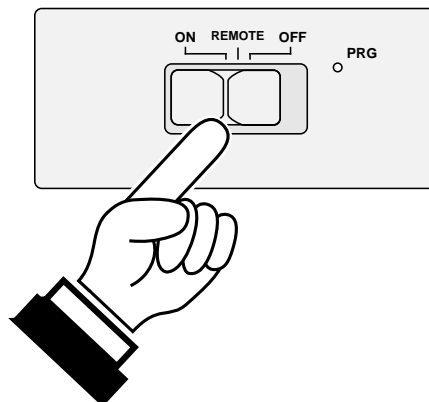

Figure 33

NOTE: When the receiver switch is turned to ON or OFF, the mode settings (Flame Height, Comfort Control) will remain in the same state as before the switch was moved (i.e.: the receiver "remembers" the last setting). If you wish to adjust the mode settings use the transmitter mode button to adjust the settings (see "Mode Controls" on page 14). The thermostat and burner on/off operating functions will not work on the transmitter.



## Remote Operation

Once the receiver is switched to “REMOTE” the transmitter operates the fireplace. Once you understand how the transmitter works, you will be able to operate your fireplace quickly and easily.

## Display Overview

The transmitter display has four main sections (see Figure 34).

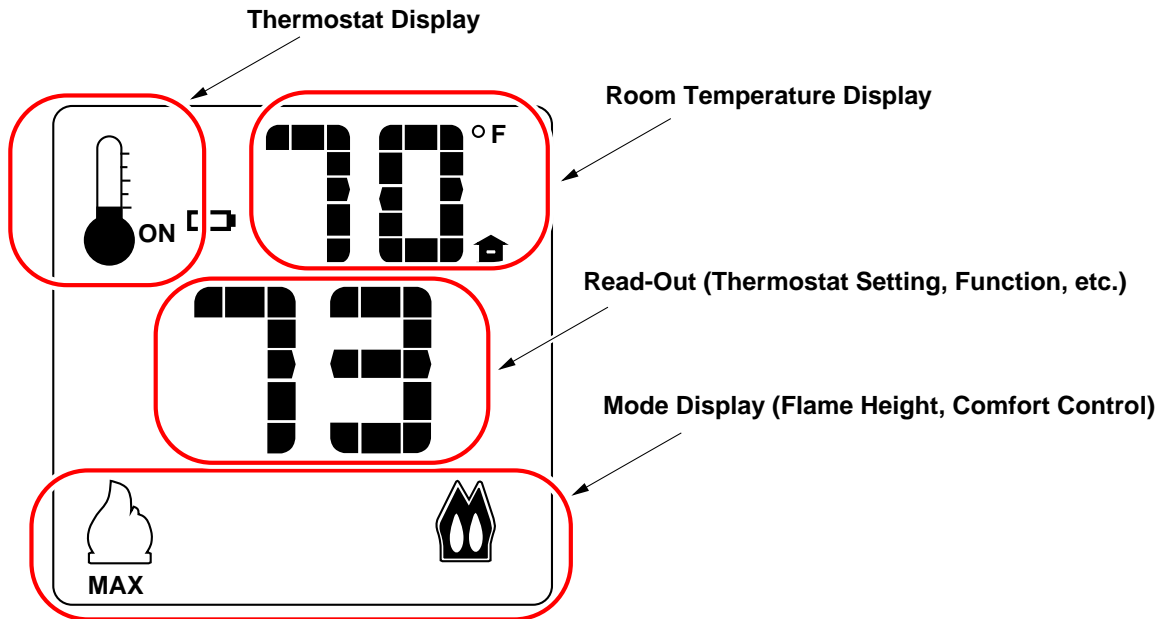

Figure 34

## Listen for the “Beep”

Each time you press a button on the transmitter that controls the fireplace, a “beep” will come from the fireplace. When you change thermostat target settings the fireplace will not beep.

**NOTE:** When the receiver batteries start to get low, the receiver will beep intermittently. When the batteries are nearly depleted, the receiver will no longer beep. See “Receiver Batteries” on page 15).



### Manual On-Off / Smart Thermostat / Standard Thermostat

Use the thermostat button to cycle through the three thermostat settings (see Figure 35).

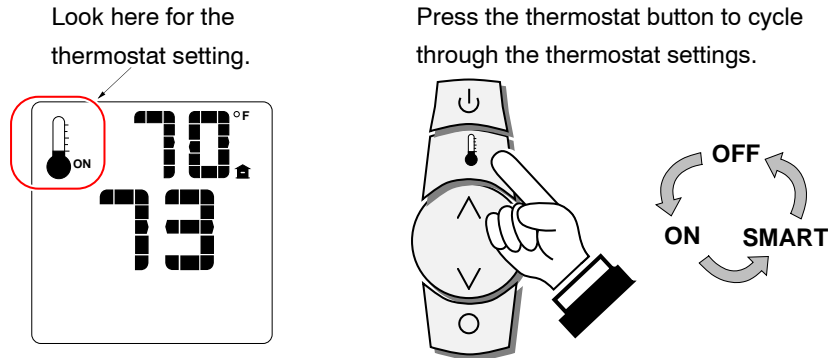

Figure 35

- **MANUAL ON/OFF** – The burner will turn on and off using the remote (see Figure 36). Press the On/Off button to control the burner. When off, the display will only show the current temperature.

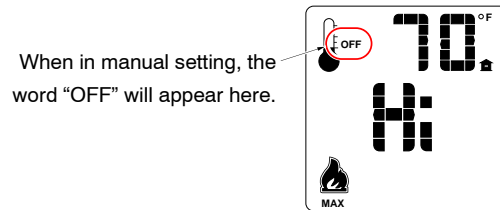

Figure 36

- **SMART THERMOSTAT** – While in smart thermostat, the transmitter will control the burner to achieve the target temperature (see Figure 37 below). Flame height will be adjusted up or down to allow operation without turning the burner on and off (also called “smart modulation”). To adjust the target temperature, press the up and down buttons until a suitable temperature is achieved.

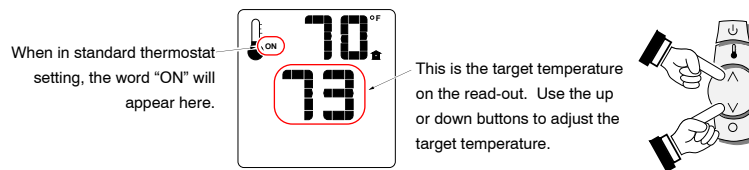

Figure 37

- **STANDARD THERMOSTAT** - While in standard thermostat setting, the transmitter will turn the burner on and off to achieve the target temperature (see Figure 38 below). To adjust the target temperature, press the up and down buttons until a suitable temperature is achieved.

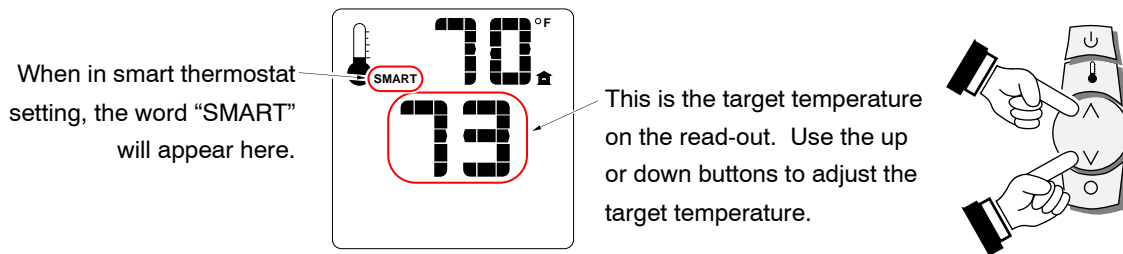

Figure 38

NOTE: if the transmitter batteries go dead while in thermostat setting (standard or smart), the appliance will shut off after approximately 24 hours.



### Mode Controls (Flame, Comfort Control)

Use the mode button to cycle through the two mode controls (see Figure 39 below).

Press the mode button to cycle through the mode settings.

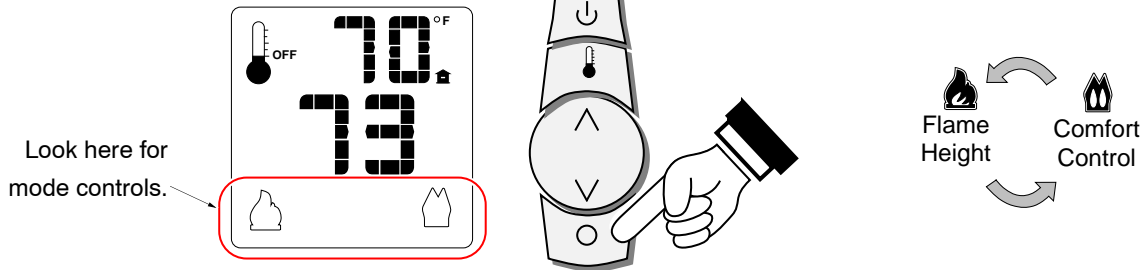

Figure 39

### Flame Height

Flame height may be controlled using the up and down buttons when in Flame Height Mode (see Figure 40 below). The center display will display the 7 settings, from “OFF” to “HI” for full on.

NOTE: Flame height may not be adjusted if operating in Smart Thermostat setting.

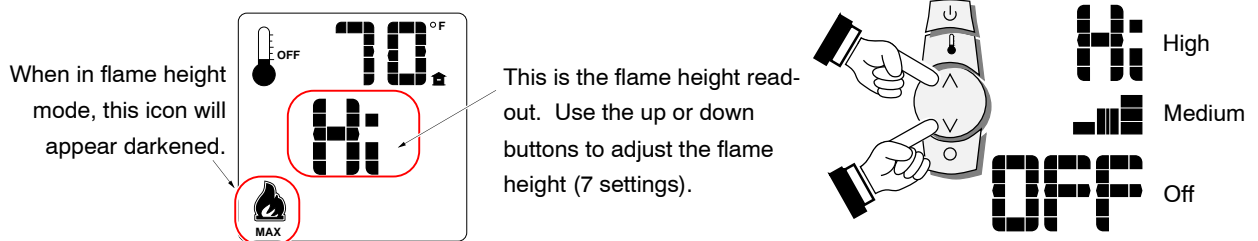

Figure 40

### Comfort Control (rear burner)

The comfort control (rear burner) may be turned on and off using the up and down buttons when in Comfort Control Mode (see Figure 41). The center display will display either “ON” or “OFF”.

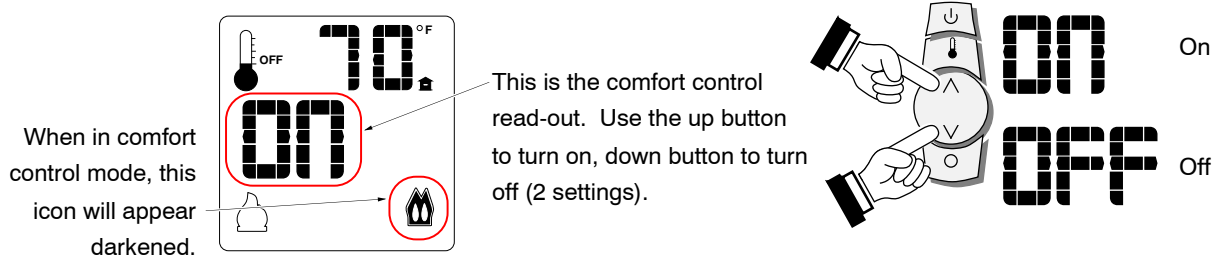

Figure 41



## Low Battery Indicator

### Transmitter Batteries

The transmitter has a battery-level indicator. When it indicates low battery voltage (see Figure 42 below), install four new AAA alkaline batteries into the transmitter (see “Transmitter Battery Installation” on page 10).

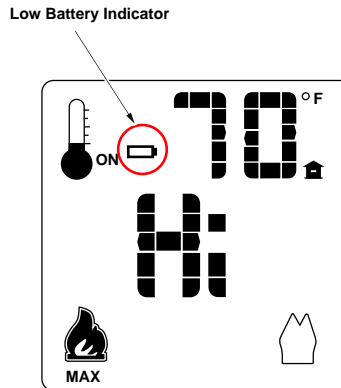

Figure 42

### Receiver Batteries

The receiver will “beep” periodically when the receiver batteries go low. Install four new AA alkaline batteries into the receiver when this occurs (see “Receiver Battery Installation” on page 10). In applications where the appliance is required to provide heat, we recommend replacing the batteries before each heating season.

## Child Proof Feature

The child proof feature disables the control buttons, preventing un-wanted use of the remote.

- Press both the MODE and UP buttons simultaneously to turn this feature on and off (see Figure 43 below).

**HINT:** This feature is especially useful while using the thermostat setting.

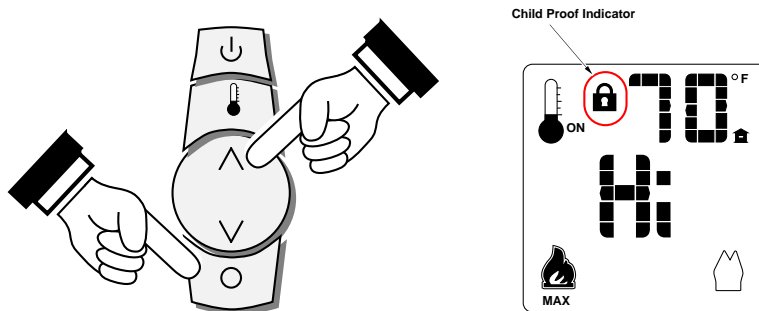

Figure 43

## Power Outages

The remote will work if household current (AC power) is disconnected. The batteries inside the receiver will continue to power the heater but the accent light and blower will not operate.