

Grande surface vitrée: 183.772 po²
 Petite surface vitrée: 51.371 po² (2)
 Surface vitrée totale: 286.514 po²

CARTOUCHE V20	FABRICANT DE POÊLES INTERNATIONAL INC. 250, rue de Copenhague, Saint-Augustin-de-Desmaures (Québec) G3A 2H3 Tél : (418) 878-3040 Fax : (418) 878-3001 www.sbi-international.com		TOLÉRANCES FRACTION : ± 1/32" .XX : ±.020" .XXX : ±.010" ANGLES : ±0.5°	 THESE ALLOWANCES ARE NOT CUMULATIVE
	NOM DE LA PIÈCE / PART NAME POÊLE OSBURN 2200 / OSBURN 2200 STOVE		RÉVISIONS / REVISIONS 02a 01/07/2014	
CONCEPTEUR E. Blouin	DESSINATEUR J-P Alain	PAGE 3 de 4	DESSIN / DRAWING NBR OB02212-W01	

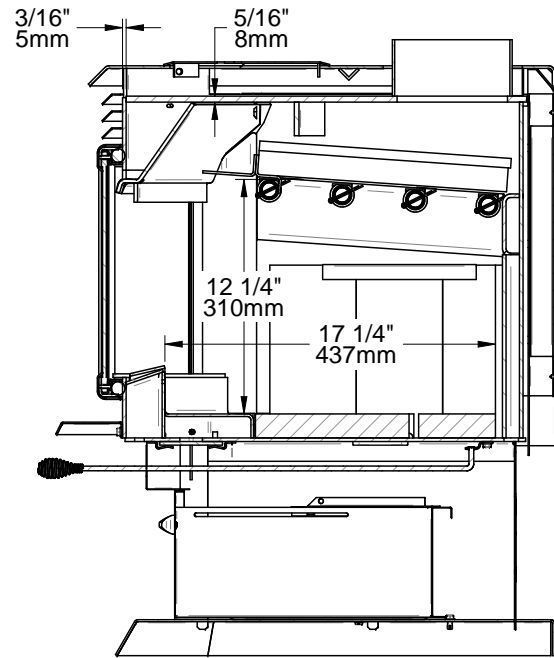

SECTION C-C

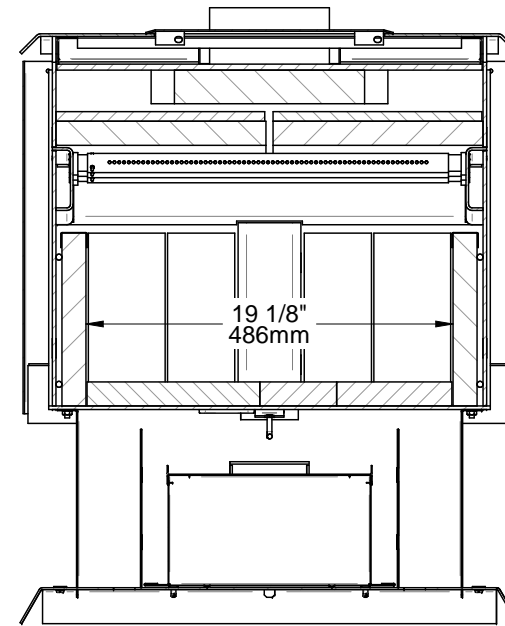

SECTION D-D

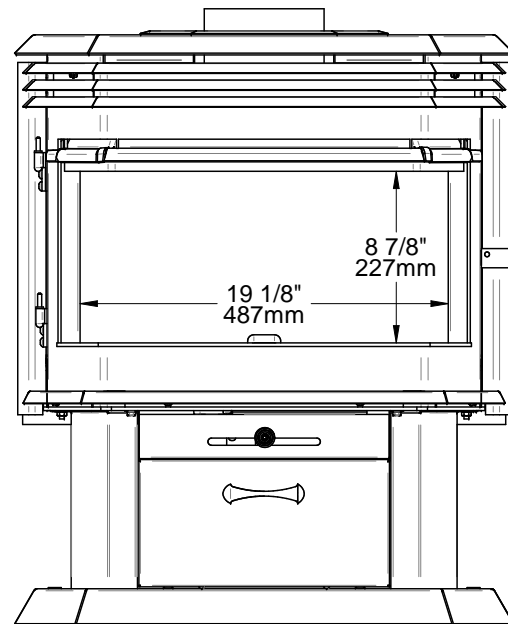

Volume de la chambre à combustion:
 4041.35po³ / 2.3387 pi³
 (0.0658 M³)

CARTOUCHE V20	FABRICANT DE POÊLES INTERNATIONAL INC. 250, rue de Copenhague, Saint-Augustin-de-Desmaures (Québec) G3A 2H3 Tél : (418) 878-3040 Fax : (418) 878-3001 www.sbi-international.com		TOLÉRANCES FRACTION : ± 1/32" .XX : ±.020" .XXX : ±.010" ANGLES : ±0.5°	 THESE ALLOWANCES ARE NOT CUMULATIVE
	NOM DE LA PIÈCE / PART NAME POÊLE OSBURN 2200 / OSBURN 2200 STOVE		RÉVISIONS / REVISIONS 01/07/2014	
CONCEPTEUR E. Blouin	DESSINATEUR J-P Alain	PAGE 4 de 4	DESSIN / DRAWING NBR OB02212-W01	